



NINZ S.p.A. - corso Trento, 2/A
I-38061 ALA (TN) / ITALY www.ninz.it
Tel. + 39 0 464 678300
Fax. +39 0 464 679025 info@ninz.it

KIT SLASH ALU BSP
PANIC EXIT DEVICE
for emergency exits

A128-GB

5001211/1 - 01/24

Commercial codes
4204301.042 KIT SLASH ALU BSP

DoP no. **1125-SL-01**
 Website <https://www.ninz.it/it/download/dop>
 Classification **3 7 7 B 1 3 2 2 B A**

Name and address
of the producer NINZ S.p.A. - corso Trento 2/A
I-38061 ALA (TN) - ITALY

Classification nr.
 1st Character - grade 3 - Category of use: high frequency
 2nd Character - grade 7 - Durability: 200.000 cycles
 3rd Character - grade 7 - Mass of the door: over 200kg
 4th Character - grade B - Suitable for use on fire/smoke rated doors
 5th Character - grade 1 - Safety: suitable for emergency exits
 6th Character - grade 3 - Highly resistant to corrosion 96h
 7th Character - grade 2 - Safety of goods: 1000N
 8th Character - grade 2 - Protrusion of the device: up to 100mm
 9th Character - grade B - Activation type: touch bar
 10th Character - grade A - Suitable for 1 or 2 leaved door



Year application
trademark 2007

Standard EN 1125:2008 + EC1:2009

Certification
authority nr. 0425

CE certification
number 0425-CPR-001308

Suitable for doors with one leaf or for the active leaf (primary) of two-leaved doors up to 1350x2880mm/leaf in size, a mass of up to 300kg/leaf, mounted on hinges or pivots, fire resistant up to EI²120 – REI120 and smoke proof. Protrusion of the exit bar: 75mm.

SYMBOLS EMPLOYED

- CAUTION**
Indicates a danger that threatens people and/or material goods. Failure to observe the warnings indicated by this symbol may have serious consequences, such as personal injury and property damage.
- ATTENTION**
Indicates a danger that threatens material goods. Failure to observe the warnings indicated by this symbol may result in damage to material goods.
- NOTICE**
Warnings related to important technical aspects.

PRODUCT DESCRIPTION

Panic bar for one-leaved doors or for the active leaf of two-leaved doors located at emergency exits and activated by touch-bar. Composed of galvanized steel controls, black plastic carter, horizontal aluminium bar, external lever handle, panic lock and nickel-plated brass cylinder with three keys.
 This product does not contain or release any hazardous materials, as per UNI EN standard nr. 1125 appendix ZA.

OPERATION MODE

While locked by key, the door cannot be opened from the pull side (handle side), while it can always be opened from the push side by using the horizontal bar of the SLASH BM panic exit device.

WARNINGS

The SLASH panic bar activated by means of a horizontal bar is intended for use onto doors installed in escape routes where panic situations could develop. The safety features of this product are of fundamental importance to ensure its conformity with EN 1125. It is strictly forbidden to introduce any type of modifications apart from those described in these installation instructions.

RECOMMENDATIONS

In order to ensure that the panic bar could provide a high level of safety toward people and appropriate safety level toward goods, it should only be mounted onto doors and doorframes that are in good conditions. The door itself, therefore, should be checked to ensure that it was installed properly and that nothing obstructs its normal movement.

If door rebate sealing have been mounted on the door, make sure they do not inhibit proper functioning of the panic bar.

In case of two-leaved door where both leaves are equipped with panic bar, it is mandatory to check that each leaf opens when its respective panic bar is activated, and that leaves open freely when the bars are activated simultaneously.

The fastening instructions in the present document should be followed scrupulously during installation. Once installation is complete, the installer should give this document to the owner of the activity.

The horizontal bar should be installed in a way that maximizes its useable length.

For securing the door in the closed position, do not employ any other latching devices than those specified in the present document. This does not preclude the installation of automatic closing devices.

Different external access devices than those found on the list of certified components on pages 4/4 are considered unacceptable.

The SLASH panic bar is also designed for installation on hollow metal doors with an internal cell structure.

If a door closer is needed to return the door to the closed position, care should be taken not to make the opening step more difficult for children, the elderly and the disabled.

A pictogram (arrow) should be positioned immediately above the horizontal bar on the internal side of the door.

All of the included components described herein must be positioned and mounted in conformity with the present document.

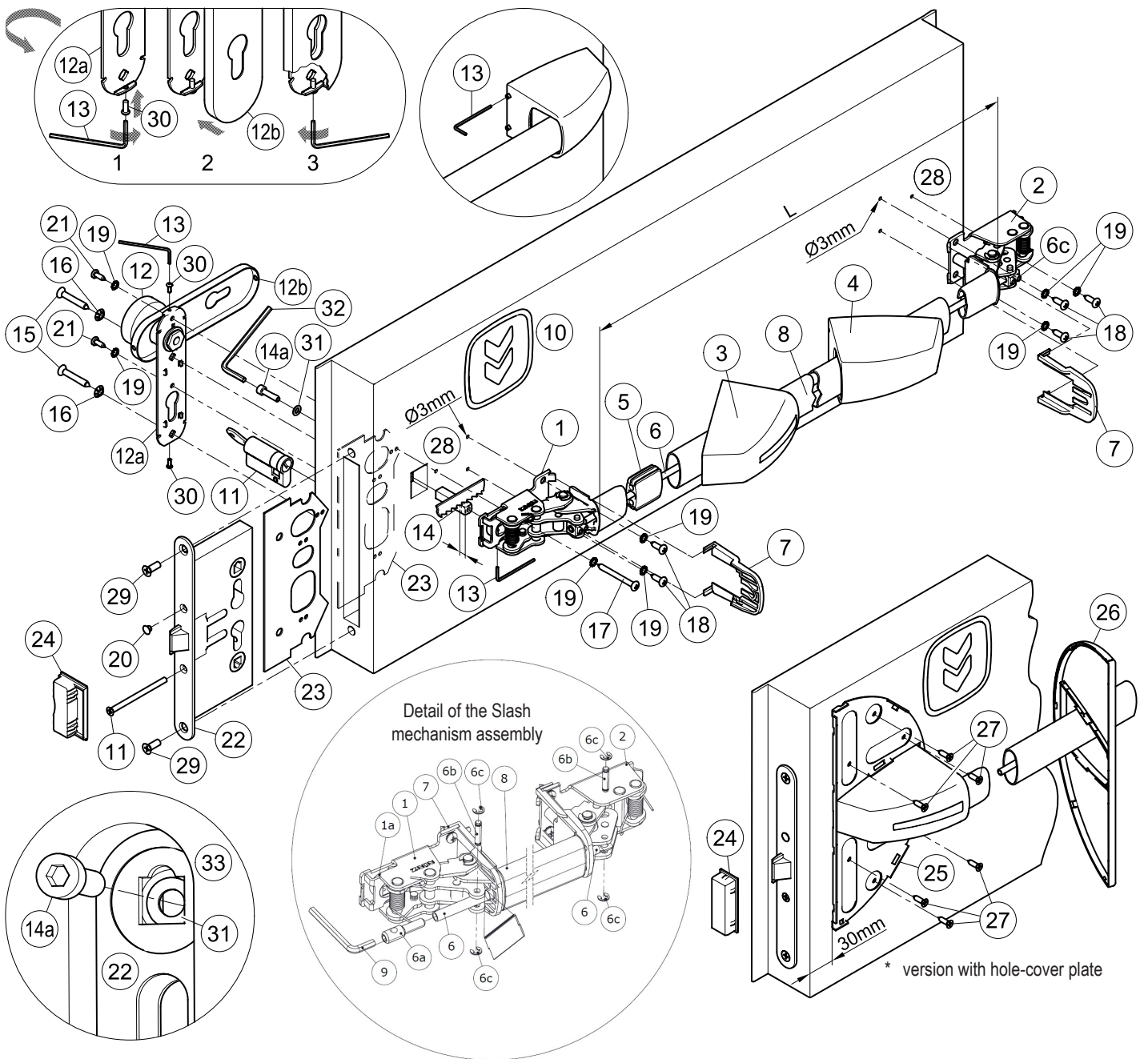

CONTENTS OF THE SLASH ALU BSP PANIC BAR KIT PACKAGE

position	pcs.	description	position	pcs.	description
1, 2	01	Slash mechanism assembly	17	01	Pan head self-tapping screw, Ø4,8x50mm (Proget+Univer) or Ø4,8x38mm (Rever)
3, 4	01	Slash ALU carter set	18	05	Pan head self tapping screw Ø4,8x16mm
5	01	Guide for connection pipe	19	08	M5 Toothed washer
6	01	Connection pipe	20	01	Black cap hole Ø8,8mm
7	02	Protection	21	02	Pan head self tapping screw Ø4,2x13mm
8	01	Horizontal bar in anodized aluminium	22	01	Panic safe lock
9	01	S3 hex key	23	01	Subplate
10	01	Adhesive pictogram (green arrow)	24	01	Proget strike box lock
11	01	Standard nickel-plated half cylinder with three keys and fastening screw	* 25	01	Hole-covering base plate
12, 12a, 12b	01	Fixed doorknob with stainless steel cover plate and galvanized steel installation plate	* 26	01	Cover for hole-covering base plate – black
13	01	S2 hex key	* 27	06	Self-drilling countersunk screw Ø4,2x16mm
14, 14a	01	9x9x40mm threaded square spindle with M5x20mm hex socket screw	30	02	M3x8mm pan head screw
15	02	Self-tapping countersunk screw Ø5,5x38mm	31	01	Washer
16	02	M6 Toothed washer	32	01	S4 hex key
			-	01	A034 hole-drilling template
			-	01	Slash ALU BSP Kit panic bar installation instructions

 Please note that article 4 of the MD of 03 November 2004 obliges the installer to write up, sign and provide the owner of the activity with a declaration of proper installation that makes explicit reference to the instructions supplied by the exit device manufacturer.

TOOLS REQUIRED



Medium-sized Philips-head screwdriver or electric screwdriver, electric drill with Ø2 and Ø3mm drill bit for steel, fine-toothed hack-saw and hack-saw for aluminium.

IMPORTANT

- Installation should be carried out by qualified personnel only and in strict conformity with the instructions supplied.
- For a correct installation all supplied components must be used, including toothed washers.
-  - No variations are allowed, and only components indicated in the package contents may be used.
- Given its purpose, the Slash ALU BSP panic bar should be mounted on the push-side of the door.
- Before proceeding with installation, check the package contents to ensure that no pieces are missing.
- Check the type of doorknob to apply and follow the specific instructions.
- Any different installation configuration from that illustrated on page 2/4 is not allowed.

INSTALLATION

- First disassemble any handles or bar components that are already present.
- Unscrew the two frontal screws (29) and take away the existing lock (22). Insert the subplate (23) in the hole intended for the lock case. Install the new panic safe lock (22) and fasten it with the same two frontal screws (29).
- Insert the half cylinder (11) and fasten it temporarily with the screw (11) then remove the key. If the hole of the subplate (23) does not match with the half cylinder, take away the lock (22) and turn the subplate upside down.
- For Rever door adjust the threaded square spindle (14) reducing its length for 5mm; be careful to cut the bevelled side.
-  - Insert the washer (31) over the square hole of the panic safe lock (22), from the pull-side of the door, as showed in drawing (33). Insert the M5x20mm screw (14a) over the washer (31) and screw it at the square spindle (14), using the S4 hex wrench (32). Make sure that washer and square spindle are correctly inserted over the square holes before tighten the screw (14a).
- Screw onto installation plate (12a) of stainless steel doorknob (12) the screws (30), just enough to insert the cover plate (12b).
- Place the doorknob (12) on the pull side of the door and fix it fastening the screws (15) and their toothed washers (16) by centering the respective holes of the subplate (23).
- Use the template to drill the holes (28) with the Ø3mm drill bit, checking the level. If holes are already present, drill them again for the internal reinforcement.
- Insert the operating mechanism (1) of the panic bar over the square spindle (14), to the lock-side (push-side of the door), with the lift of the cam (1a) turned downwards. Fasten the mechanism starting with the two Ø4,8x16mm screws (18), then with the Ø4,8x50mm (Proget/Univer) or Ø4,8x38mm (Rever) screw (17), with their toothed washers (19).
- Fix the square spindle (14) at the operating mechanism (1), using the S2 hex wrench (13).
- In case of Univer and Rever doors, apply the hole-covering base plate (25) after having provisionally clipped on the carter (3) on the mechanism. Center it vertically above the carter and at a distance of 30mm from the edge of the leaf (see drawing). Fasten the hole-covering base plate provisionally with the two more external screws (27) by first drilling holes in the metal panel with the Ø2mm drill bit, then positioning the cover (26) to verify that it attaches correctly without interfering with the carter. If everything matches, complete fastening with the remaining screws (27) after removing the cover (26) and the carter (3).
- Fasten the mechanism (2) of the panic bar at hinged side, using the self-tapping screws Ø4,8x16mm (18) and their toothed washers (19).
- Make a precise "L" measurement, cut the horizontal aluminium bar (8), and remove the burrs from the cut edge. Insert the guide (5) for the connection pipe in the center of the bar (8).
- Take out the mechanism (2) in order to insert the horizontal bar (8) in the operating mechanism (1); then insert also the connection pipe (6).
- Insert the carters in the horizontal bar, first the one with the sticker (3), then the other one without (4). Join the bar with the hinged side mechanism (2) inserting also the connection pipe (6) before refastening the mechanism at the door. The flattened side of the pipe (6) has to be inserted from hinge side.
- Fasten the connection pipe (6) from the hinge side inserting the blocking pin (6b) in the provided hole in the connection pipe (6) and fastening with the 2 seeger rings (6c).
- Maintaining pulled the horizontal bar (8) cut the connection pipe (6) leaving it protruding for about 5mm from the operating bar (8). Insert then the pin (6a) in the connection pipe by means of the hexagonal key S3 (9). The pin has to be fastened until the holes for the blocking pin (6b) are centered. Insert then the blocking pin (6b) in the hole of the connection pin (6a) and fastening it with the 2 seeger rings (6c).





- Insert the protections (7) in the designated guides of both mechanisms.
- Apply the carters (3 and 4) on the relative mechanisms while ensuring that the protections (7) remain in their position. Clip on the carters by pushing softly the horizontal bar; first the narrow side, then the wide side. Finally fix the carters fastening their socket set screw without forcing, using the S2 hex key (13).
- Finish fastening the half cylinder (11), insert the little cap hole (20) in the open hole of the panic safe lock (22).
-  - Push the Slash ALU BSP panic bar at any point along the horizontal bar, checking to ensure that the latch bolt opens easily and fully. Use the same method to check the external side, using the key to retract the latch bolt. Test the door in both open and closed positions, and if necessary file down the plastic strike box (24) of one-leaved doors, or the panic safe lock for inactive leaf of two-leaved doors.
- Fasten additionally the installation plate (12a) of stainless steel doorknob (12) using the self-tapping screws Ø4,2x13mm (21) and their toothed washers (19) after drilling holes in the metal panel with the Ø2mm drill bit.
- Insert the cover plate (12b) onto installation plate (12a) (drw. 2). Using the S2 hex key (13), unscrew the screws (30) until the cover become fixed, avoiding any deformation (drw. 3).
- Apply the pictogram (10) with the green arrow on the internal surface of the door, just above the horizontal bar.
-  - Lastly, use a dynamometer to measure the force required on the horizontal bar to release the lock. Record this force measurement in the present document.

USE

- Ensure that the door always opens easily.
- Avoid unnecessary strains on or handling onto doorknob and exit bar.
- Protect the panic bar from external atmospheric agents.
- Ensure that nothing hinders the free movement of the horizontal bar.
- Do not paint the lock.
- Use the bar properly, do not pull it in the wrong direction.
- Do not leave the key in the lock.
-  - Make sure that any damaged or malfunctioning parts are replaced immediately.

MAINTENANCE

To ensure that door usage conforms with regulations, the following maintenance checks should be carried out at least once a month:

- Confirm that all of the installed components correspond with those listed in the present instructions and that no other latching devices than those originally installed have been added to the door.
- Inspect and activate the panic bar to verify that all of its components are in satisfactory operational condition.
- Use a dynamometer to confirm that the release force shows no significant differences from the forces recorded at the time of installation.
-  - Check whether all screws are fully tightened, tightening any that may have loosened.
- Check whether panic bar and key can be moved with minimal effort, and that the latch bolt of the lock retreats from the strike box without offering resistance. If the door has become difficult to open due to friction, the resistance can be reduced by filing the strike box down to the appropriate height.
- Activate the Slash ALU BSP panic bar at both ends of the horizontal bar, checking to ensure full retraction of the latch bolt in both cases.
- Ensure that the latch bolt exits completely when the horizontal bar is released.
- Check the horizontal bar and replace it if any damage or deformities are detected.
-  - Check whether the inserts and strike boxes are blocked in any way and eliminate any obstructions.
- This product requires no special maintenance. Grease spray should be used to lubricate the internal workings of the lock and panic bar on a regular basis - the latter has a hole on its carter for this purpose.
- For normal cleaning use a cleaning agent designed specifically for chrome-polished surfaces for the horizontal bar and another one designed specifically for stainless steel for the doorknob.
-  - Any adjustments that become necessary must be carried out by qualified personnel using original NINZ replacement parts.
-  - The owner of the activity is responsible for keeping the declaration of correct installation on file, conducting proper panic bar maintenance in accordance with all of the manufacturer's maintenance guidelines, keeping maintenance and check-up records and preserving the present document.

