

COMMERCIAL CODES
 SLASH B for PROGET doors art. 4201101.061

Name and address of the producer
 NINZ S.p.A. - corso Trento 2/A
 I-38061 ALA (TN) - ITALY



Year application trademark
 2007

Standard
 EN 1125:2008 + EC1:2009

Certification authority nr.
 0425

CE certification number
 0425-CPR-001308

DoP no. **1125-SL-01**
 Website <https://www.ninz.it/it/download/dop>
 Classification **3 7 7 B 1 3 2 2 B A**

Classification no.
 1st Character - grade 3 - Category of use: high frequency
 2nd Character - grade 7 - Durability: 200.000 cycles
 3rd Character - grade 7 - Mass of the door: over 200kg
 4th Character - grade B - Suitable for use on fire/smoke rated doors
 5th Character - grade 1 - Safety: suitable for emergency exits
 6th Character - grade 3 - Highly resistant to corrosion 96h
 7th Character - grade 2 - Safety of goods: 1000N
 8th Character - grade 2 - Protrusion of the device: up to 100mm
 9th Character - grade B - Activation type: touch bar
 10th Character - grade A - Suitable for 1 or 2 leaved door

Suitable for doors with one leaf or for the active leaf (primary) of two-leaved doors up to 1350x2880mm/leaf in size, a mass of up to 300kg/leaf, mounted on hinges or pivots, fire resistant up to EI²120 – REI120 and smoke proof. Protrusion of the exit bar: 75mm.

SYMBOLS EMPLOYED



CAUTION
 Indicates a danger that threatens people and/or material goods. Failure to observe the warnings indicated by this symbol may have serious consequences, such as personal injury and property damage.



ATTENTION
 Indicates a danger that threatens material goods. Failure to observe the warnings indicated by this symbol may result in damage to material goods.



NOTICE
 Warnings related to important technical aspects.

PRODUCT DESCRIPTION

Panic bar for one-leaved doors or for the active leaf of two-leaved doors located at emergency exits and activated by touch-bar. Composed of galvanized steel controls, black plastic carter and horizontal aluminium bar.

This product does not contain or release any hazardous materials, as per UNI EN standard nr. 1125 appendix ZA.

OPERATION MODE

From the pull side (without external holes) the door can not be opened. Opening is possible from the push side at any time by pushing on the horizontal bar of the SLASH B panic bar.

WARNINGS

The SLASH panic bar activated by means of a horizontal bar is intended for use onto doors installed in escape routes where panic situations could develop.

The safety features of this product are of fundamental importance to ensure its conformity with EN 1125. It is strictly forbidden to introduce any type of modifications apart from those described in these installation instructions.

RECOMMENDATIONS

In order to ensure that the panic bar could provide a high level of safety toward people and appropriate safety level toward goods, it should only be mounted onto doors and doorframes that are in good conditions. The door itself, therefore, should be checked to ensure that it was installed properly and that nothing obstructs its normal movement.

If door rebate sealing have been mounted on the door, make sure they do not inhibit proper functioning of the panic bar.



In case of two-leaved door where both leaves are equipped with panic bar, it is mandatory to check that each leaf opens when its respective panic bar is activated, and that leaves open freely when the bars are activated simultaneously.

The fastening instructions in the present document should be followed scrupulously during installation. Once installation is complete, the installer should give this document to the owner of the activity.

The horizontal bar should be installed in a way that maximizes its useable length.

For securing the door in the closed position, do not employ any other latching devices than those specified in the present document. This does not preclude the installation of automatic closing devices.

Different external access devices than those found on the list of certified components on pages 4/4 are considered unacceptable.

The SLASH panic bar is also designed for installation on hollow metal doors with an internal cell structure.

If a door closer is needed to return the door to the closed position, care should be taken not to make the opening step more difficult for children, the elderly and the disabled.

A pictogram (arrow) should be positioned immediately above the horizontal bar on the internal side of the door.



All of the included components described herein must be positioned and mounted in conformity with the present document.

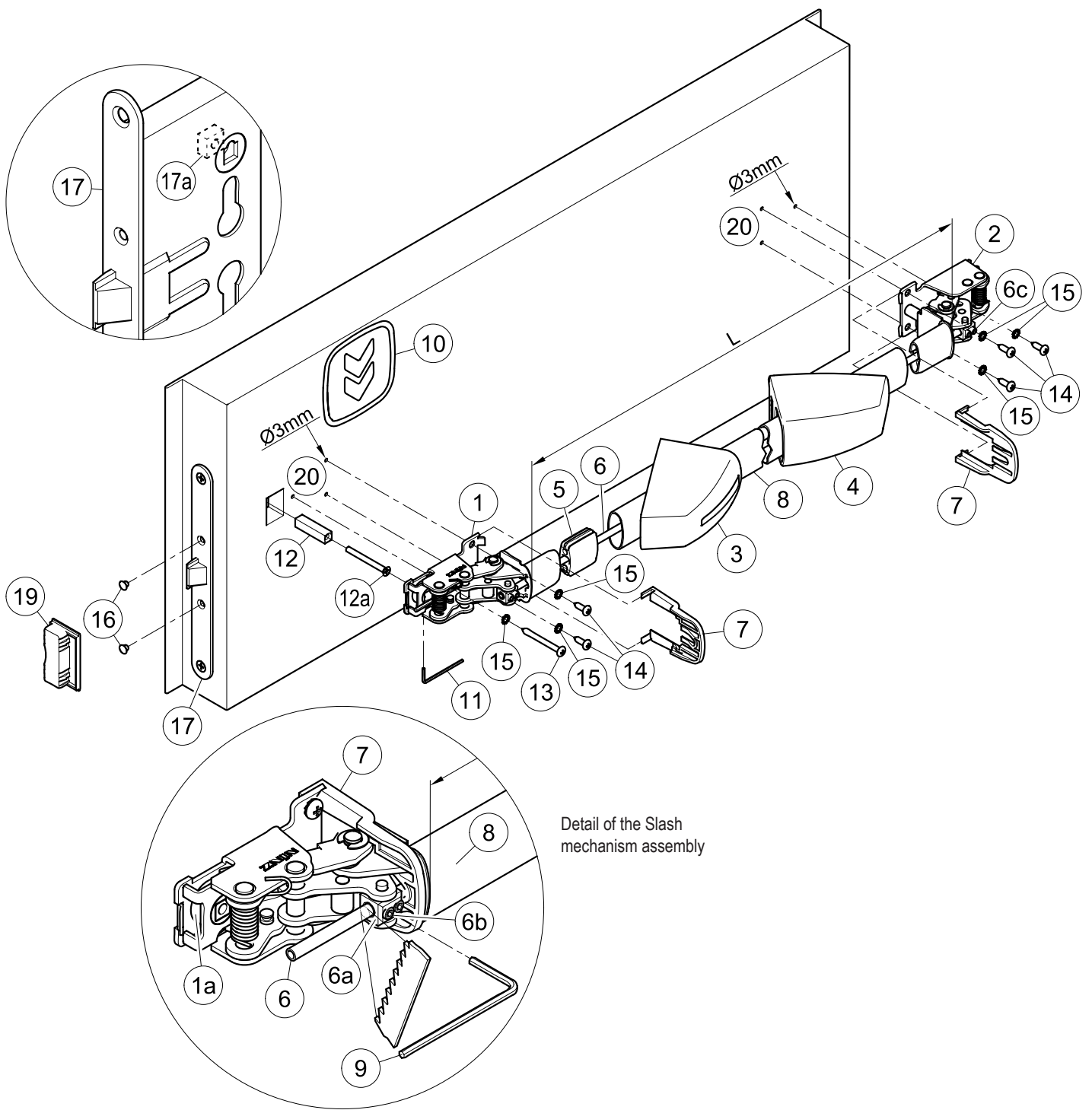

Detail of the Slash mechanism assembly

CONTENTS OF THE SLASH B PANIC BAR PACKAGE

position	pcs.	description	position	pcs.	description
1, 2	01	Slash mechanism assembly	12, 12a	01	9x9x38mm square spindle with hole to pass and M5x50mm Philips-head countersunk screw
3, 4	01	Slash carter set	13	01	Pan head self-tapping screw, Ø4,8x50mm
5	01	Guide for connection pipe	14	05	Pan head self tapping screw Ø4,8x16mm
6	01	Connection pipe	15	06	Toothed washer
7	02	Protection	16	02	Black cap hole Ø8,8mm
8	01	Horizontal bar in anodized aluminium	-	01	A034 hole-drilling template
9	01	S3 hex key	-	01	Slash B Proget panic bar installation instructions
10	01	Adhesive pictogram (green arrow)			
11	01	S2 hex key			

 Please note that article 4 of the MD of 03 November 2004 obliges the installer to write up, sign and provide the owner of the activity with a declaration of proper installation that makes explicit reference to the instructions supplied by the exit device manufacturer.

 - The panic lock (17) and the respective strike box (counterstrike) (19) are delivered already mounted on the door!



TOOLS REQUIRED

Medium-sized Philips-head screwdriver or electric screwdriver, electric drill with Ø3mm drill bit for steel, fine-toothed hack-saw and hack-saw for aluminium.

IMPORTANT

- Installation should be carried out by qualified personnel only and in strict conformity with the instructions supplied.
- For a correct installation all supplied components must be used, including toothed washers.
-  - No variations are allowed, and only components indicated in the package contents may be used.
- Given its purpose, the Slash B panic bar should be mounted on the push-side of the door.
- Before proceeding with installation, check the package contents to ensure that no pieces are missing.
- Check if the door is equipped with the panic safe lock.
- Any different installation configuration from that illustrated on pag. 2/4 is not allowed.

INSTALLATION



-  - Insert the M5x50mm screw (12a) into the countersunk hole of the square spindle (12) and fasten it at the threaded insert (17a) of the panic safe lock (17) by tightening well the screw.
- Use the template to drill the holes (20) with the Ø3mm drill bit, checking the level. If holes are already present, drill them again for the internal reinforcement.
- Insert the operating mechanism (1), with the lift of the cam (1a) turned downwards, over the square spindle (12). Fasten the mechanism (1) starting with the two Ø4,8x16mm screws (14), then with the Ø4,8x50mm screw (13), with their toothed washers (15).
- Fix the square spindle (12) at the operating mechanism (1), using the S2 hex wrench (11).
- Fasten the mechanism (2) of the panic bar at hinged side, using the self-tapping screws Ø4,8x16mm (14) and their toothed washers (15).
- Make a precise "L" measurement, cut the aluminium bar (8), and remove the burrs from the cut edge. Insert the guide (5) for the connection pipe in the center of the bar.
- Take out the mechanism (2) in order to insert the horizontal bar (8) in the operating mechanism (1); then insert also the connection pipe (6) until it passes through the block (6a).
- Insert the plastic carters in the horizontal bar, first the one with the sticker (3), then the other one without (4). Join the bar with the hinged side mechanism (2) inserting also the connection pipe (6) before re-fastening the mechanism at the door.
- Fasten provisionally the connection pipe (6) so that it not protrudes from the block, by screwing the two socket set screws (6c) of the hinged side mechanism (2) with the S3 hex key (9).
- Maintaining pulled the horizontal bar (8) block the connection pipe (6) by screwing lightly the two socket set screws (6b) of the mechanism at lock side (1). Then verify that the latch bolt retracts completely by pushing the end of the bar from hinged side. If so screw the four socket set screws (6b and 6c) until they not protrude from the block. Otherwise loosen the socket set screws and repeat the operation, making sure that the connection pipe is kept under tension. Lastly cut off the protruding piece of the connection pipe.
- Insert the protections (7) in the designated guides of both mechanisms.
- Apply the carters (3 and 4) on the relative mechanisms while ensuring that the protections (7) remain in their position. Clip on the carters by pushing softly the horizontal bar; first the wide side, then the narrow side.
- Insert the two caps (16) in the open holes of the panic safe lock (17).
-  - Push the Slash B panic bar at any point along the horizontal bar, checking to ensure that the latch bolt opens easily und fully. Test the door in opened and closed position and if necessary file down the plastic strike box (19) of one-leaved doors or the panic safe lock for inactive leaf of two-leaved doors.
- Apply the pictogram (10) with the green arrow on the internal surface of the door, just above the horizontal bar.
-  - Lastly, use a dynamometer to measure the force required on the horizontal bar to release the lock. Record this force measurement in the present document.



USE

- Ensure that the door always opens easily.
- Avoid unnecessary strains on or handling of the exit bar.
- Protect the panic bar from external atmospheric agents.
- Avoid anything that could hamper the free movement of the bar.
- Do not paint the lock.
- Use the bar properly, do not pull it in the wrong direction.
-  - Make sure that any damaged or malfunctioning parts are replaced immediately.

MAINTENANCE

To ensure that door usage conforms with regulations, the following maintenance checks should be carried out at least once a month:

- Confirm that all of the installed components correspond with those listed in the present instructions and that no other latching devices than those originally installed have been added to the door.
- Inspect and activate the panic bar to verify that all of its components are in satisfactory operational condition.
- Use a dynamometer to confirm that the release force shows no significant differences from the forces recorded at the time of installation.
-  - Check whether all screws are fully tightened, tightening any that may have loosened.
- Check whether exit bar can be moved with minimal effort, and that the latch bolt retreats from the strike box without offering resistance. If the door has become difficult to open due to friction, the resistance can be reduced by filing the strike box down to the appropriate height.
- Activate the Slash B panic bar at both ends of the horizontal bar, checking to ensure full retraction of the latch bolt in both cases.
- Ensure that the latch bolt exits completely when the horizontal bar is released.
- Check the horizontal bar and replace it if any damage or deformities are detected.
-  - Check whether the inserts and strike boxes are blocked in any way and eliminate any obstructions.
- This product requires no special maintenance. Grease spray should be used to lubricate the internal workings of the lock and panic bar on a regular basis
 - the latter has a hole on its carter for this purpose.
- For normal cleaning use mild detergents.

-  - Any adjustments that become necessary must be carried out by qualified personnel using original NINZ replacement parts.
-  - The owner of the activity is responsible for keeping the declaration of correct installation on file, conducting proper exit bar maintenance in accordance with all of the manufacturer's maintenance guidelines, keeping maintenance and check-up records and preserving the present document.

